



BP-SH3R 3" CHIPPING HAMMER



Actual product may be slightly different from the product described herein.

Tool Specification:

Bore Size:	1-1/8"
Blows Per Minute :	1,700 RPM
Stroke length Inch:	3
Air Inlet:	3/8" NPT
Hose Size:	1/2" I.D.
Average Air Consumption:	8 CFM
Weight:	7.3 KG

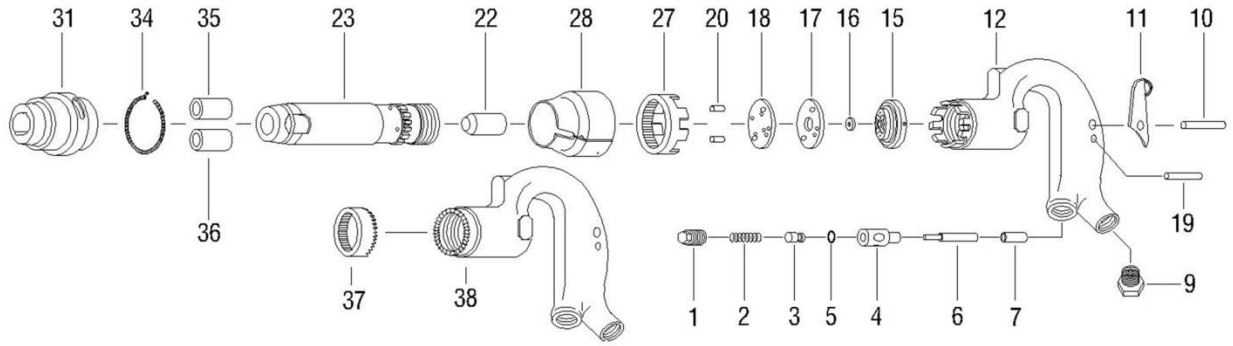

IndexNo.	Part No.	Desc	Q'ty	No.	Part No.	Desc	Q'ty
1	BP-SH1R01	Plug-Throttle Valve (1/2"PT)	1	20	BP-SH1R20	Pin-Bowel (7.8*22.)	2
2	BP-SH1R02	Spring- Throttle Valve	1	22	BP-SH1R22	Piston (1"~2")	1
3	BP-SH1R03	Valve-Throttle	1		BP-SH3R22	Piston (3")	1
4	BP-SH1R04	Bushing-Throttle Vlive	1		BP-SH4R22	Piston (4")	1
5	BP-SH1R05	O-Ring (6*2)	1	23	BP-SH1R23	Cylinder (1 ")	1
6	BP-SH1R06	Pin-Push	1		BP-SH2R23	Cylinder.(2")	1
7	BP-SH1R07	Bushing-Pin Push	1		BP-SH3R23	Cylinder (3")	1
9	BP-SH1R08	Bushing-Permanent	1		BP-SH4R23	Cylinder (4")	1
10	BP-SH1R09	Pin-Throttle Lever (6*20)	1	27	BP-SH1R27	Lock	1
11	BP-SH1R10	Lever-Throttle	1	28	BP-SH1R28	Shield-Lock	1
12	BP-SH1R11	Handle	1	31	BP-SH1R31	Sleeve-Retainer	1
15	BP-SH1R15	Lid-Upper Valve Case	1	34	BP-SH1R34	Spring-Lockcoil	1
16	BP-SH1R16	Valve	1	35	BP-SH1R35	Bushing-Cylinder (R)	1
17	BP-SH1R17	Case-Valve	1	36	BP-SH1R36	Bushing-Cylinder (H)	1
18	BP-SH1R18	Lid-Lower Valve Case	1	37	BP-SH1R37	Lock	1
19	BP-SH1R19	Pin-Stop (5*28)	1	38	BP-SH1R38	Handle	1

AIR SUPPLY SETUP AND CONNECTION

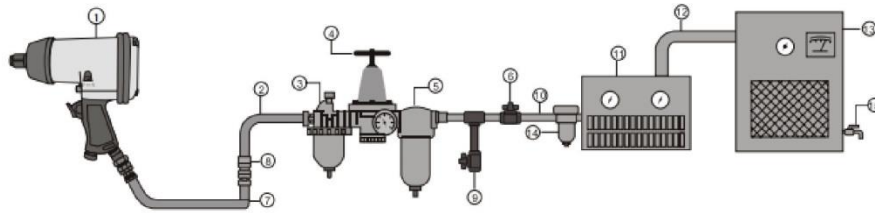

AIR SYSTEM LAYOUT:

- | | | |
|-------------------------|-------------------------------------|-----------------------------------|
| 1. Air Tool | 6. Shut Off Valve | 11. Air Dryer |
| 2. Air Hose 3/8" (I.D.) | 7. Whip Hose | 12. 1" Or Larger Pipe And Fitting |
| 3. Oiler | 8. Coupler Body And Connector | 13. Air Compressor |
| 4. Pressure Regulator | 9. Drain Daily | 14. Auto Drain |
| 5. Filter | 10. 1/2" Or Larger Pipe And Fitting | 15. Drain Daily |

1. For optimal results you should incorporate a regulator, oiler and an inline filter.
2. If you are not using an automatic lubricating system, before operating the tool, add a few drops of Pneumatic Tool Oil to the air-line connection. Add more after each hour of constant using.
3. Do not exceed maximum air pressure of 90 PSI/ 6.2 bar or as stated on tool nameplate.

To prevent serious injury, read and understand all warning and instructions before use.

SAFETY RULES



READ, UNDERSTAND AND KEEP THESE INSTRUCTIONS,
WARNING Failure to follow all instructions listed below may result in serious injury.

WORK AREA HAZARD & PERSONAL SAFETY

1. Keep your work area clean and well lit.
2. Do not operate power tools in explosive atmospheres, such as in the presence of combustible liquid, gases or dust. Power tools create sparks which may ignite the dust or fumes.
3. Disconnect tool before performing service or when not in use.
4. High sound levels can cause permanent hearing loss. Use hearing protection during operation.
5. Maintain a balanced body position and secure footing.
6. Slips/Trips/Falls are a major cause of serious injury or death. Be aware of excess hose left on the working floor.
7. Repetitive work motions, awkward positions and exposure to vibration can be harmful to hands and arms. If numbness, tingling, pain or whitening of the skin occurs, stop using the tool and consult a physician.
8. Always wear impact-resistant eye and face protection when operating, repairing or performing maintenance of the tool or while changing tool accessories.

TOOL USE AND CARE

1. Use support handle or other method to secure and support the work piece to a stable

platform.

2. Do not force the tool. Use the correct tool for your application. Using the correct tool which is specifically designed for a select job will provide better tool performance and make the job easier.
3. Disconnect the air supply before making any adjustments, changing accessories, or storing the tool. Always disconnect the air supply before performing any inspection, maintenance or tool cleaning.
4. Use only accessories recommended by the manufacturer for your model.
5. When using a tool that is designed to have a guard, the guard should be in place to provide protection from flying debris, grinding residue or sparks.
6. Do not leave the tool unattended when it is connected to an air supply.
7. Use compressed air only.

OPERATING INSTRUCTIONS

ONLY use accessories recommended by Sunmatch. Check the position of the reversing mechanism before operating the tool so as to be aware of the direction of rotation when operating. Use only impact sockets and accessories. Do not use the hand sockets or accessories. Check the drive end of the tool to make sure that the socket retainer functions correctly and that sockets and drive ends are not excessively worn which may allow the socket to come off when rotating. Connections requiring specific torque must be checked with a torque meter after fitting with an impact wrench.

LUBRICATION & MAINTENANCE

Lubricate the tool daily with a high grade of air tool oil. If no air line oiler is used, run a teaspoon of oil through the tool. The oil can be squirted into the tool air inlet, or into the hose at the nearest connection to the air supply, prior to operating the tool. A rust inhibitive oil is acceptable for air tools.



Boston Pneumatic Tools and Assembly Systems

Tel : +1 (214) 586 3765
www.bostonpneumatic.com